

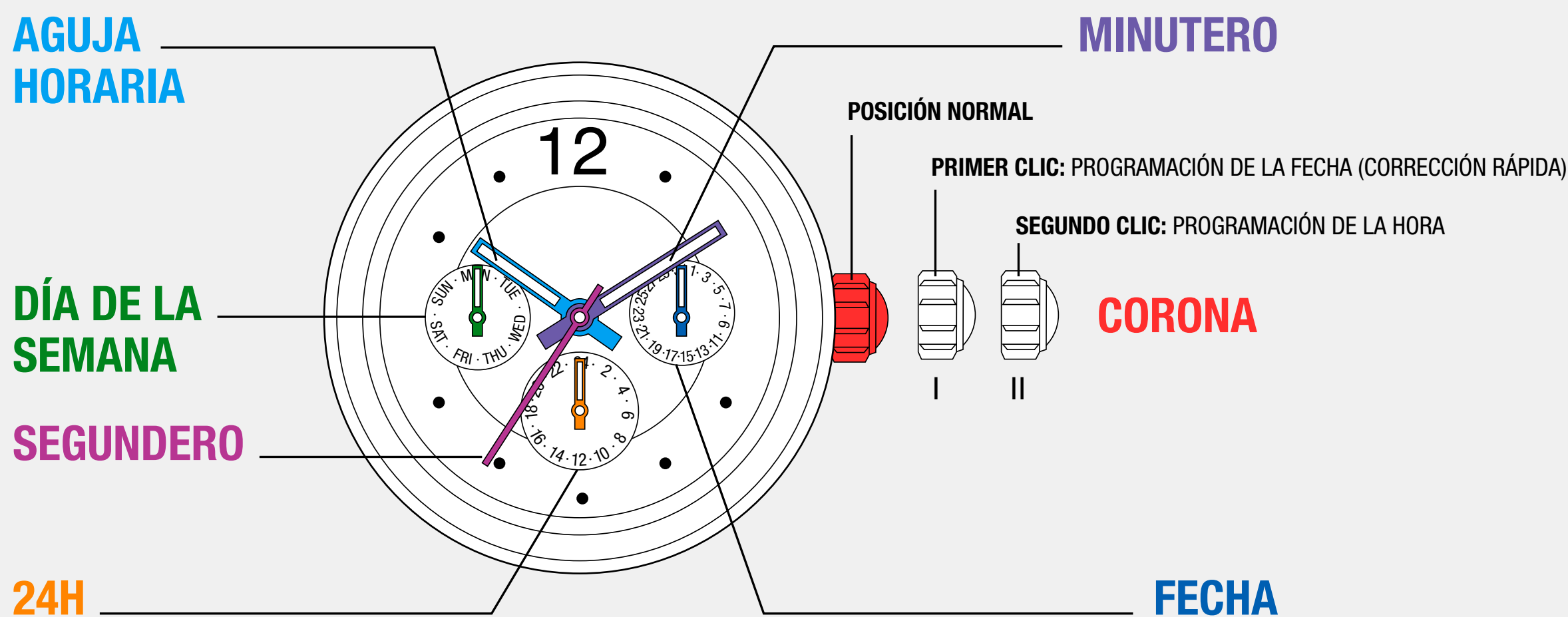

FUNCIONAMIENTO DE LA PANTALLA Y DE LA CORONA



PROGRAMACIÓN DE LA HORA

1

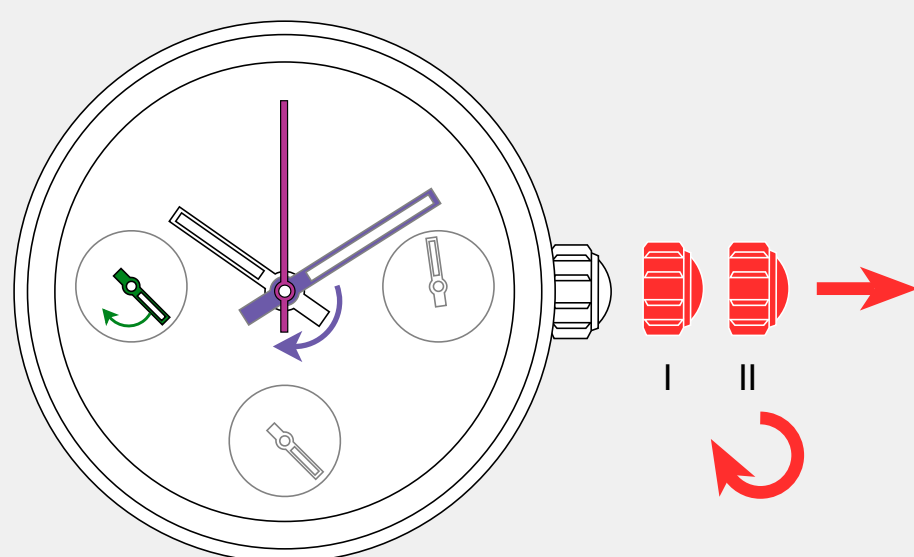

Saque la corona hasta la posición del segundo clic cuando la manecilla de los segundos esté en la posición de las 12 horas.

Gire la corona para programar el día de la semana.

Gire la corona para avanzar la manecilla de la hora y la manecilla de los minutos hasta la hora deseada (asegúrese de fijar AM/PM correctamente)

2

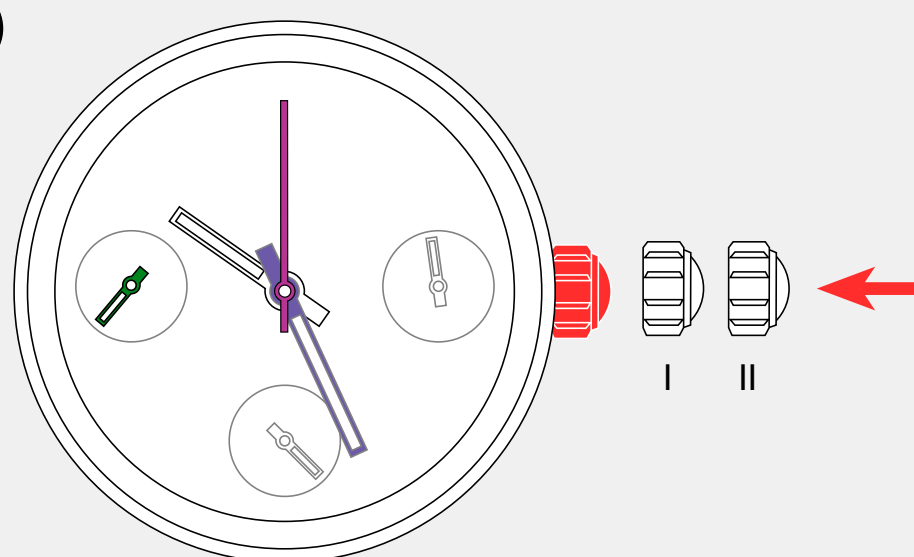

Empuje la corona de nuevo hacia la posición normal según la señal horaria.

3

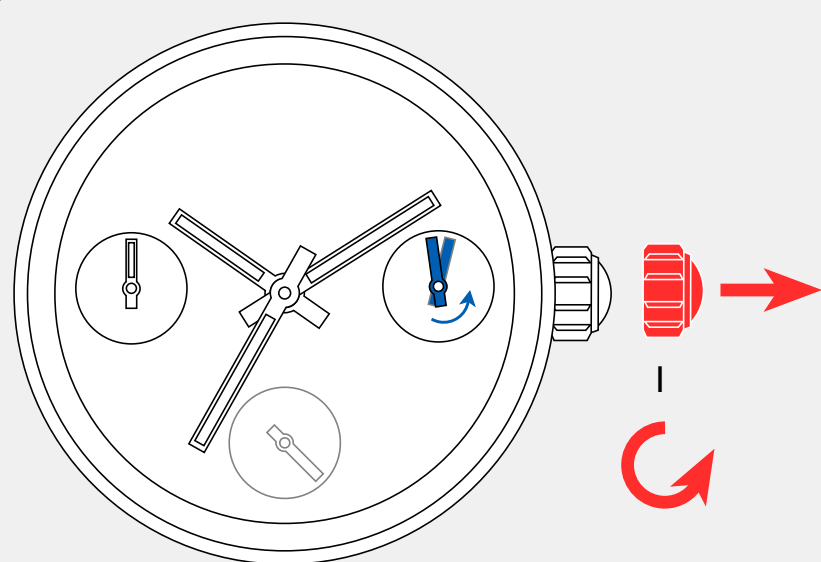

Saque la corona hasta el primer clic. Gire la corona contra el sentido de las manecillas del reloj para ajustar la fecha.

4

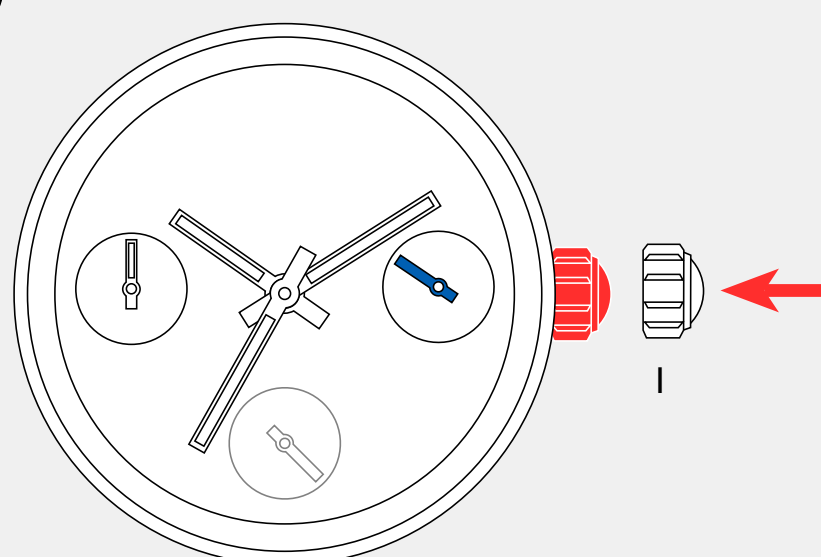

Empuje la corona de nuevo hacia la posición normal.

• Para prevenir errores en el cambio del día, no programe la fecha entre las 10:00PM y las 2:00AM. Si es necesario programar la fecha en este tiempo, cambie la hora primero, fijando cualquier hora fuera de este periodo, luego llegue a la fecha deseada. Después programe la hora correcta.



DISPLAY AND CROWN OPERATION

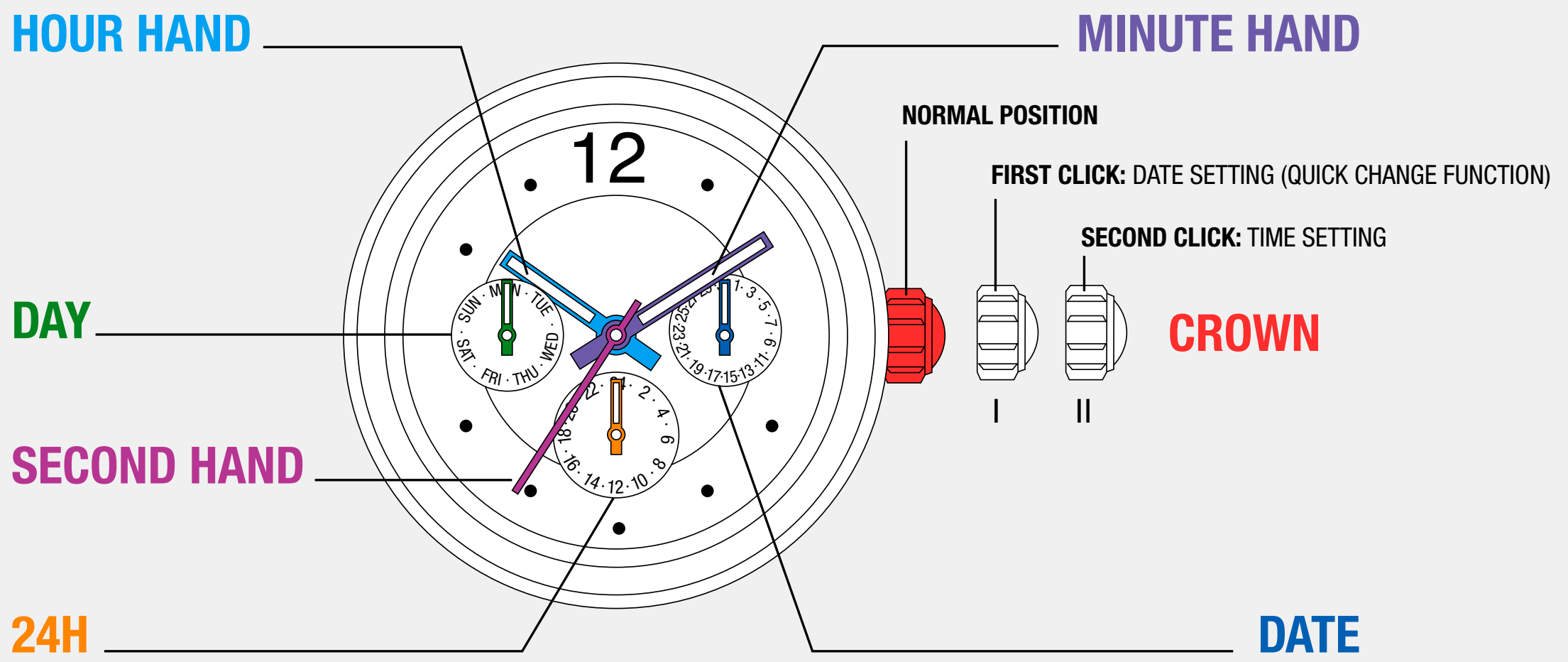

TIME SETTING

①

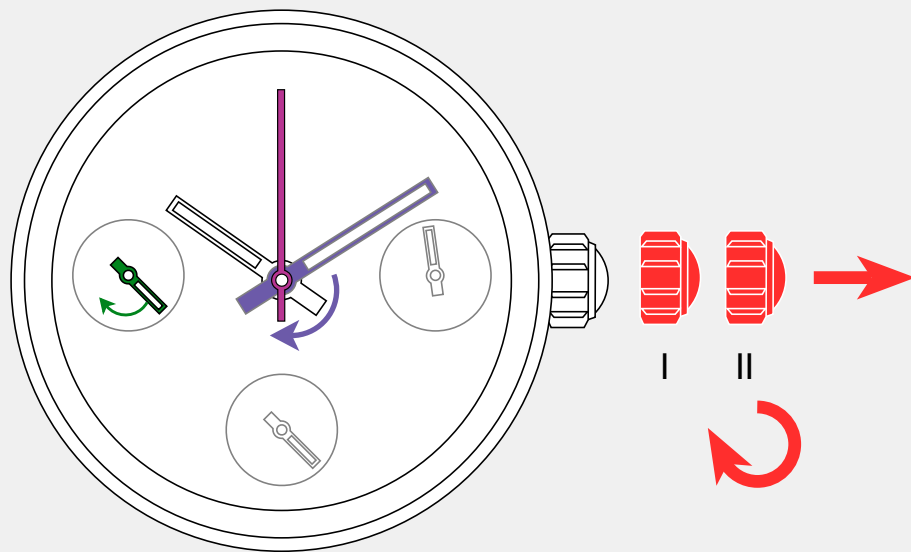

Pull out the crown to the second click when the second hand is at the 12 o'clock position.

Rotate the crown to set the day of the week.

Turn the crown to set the hour hand and minute hand to the correct time (check that AM/PM is set correctly)

②

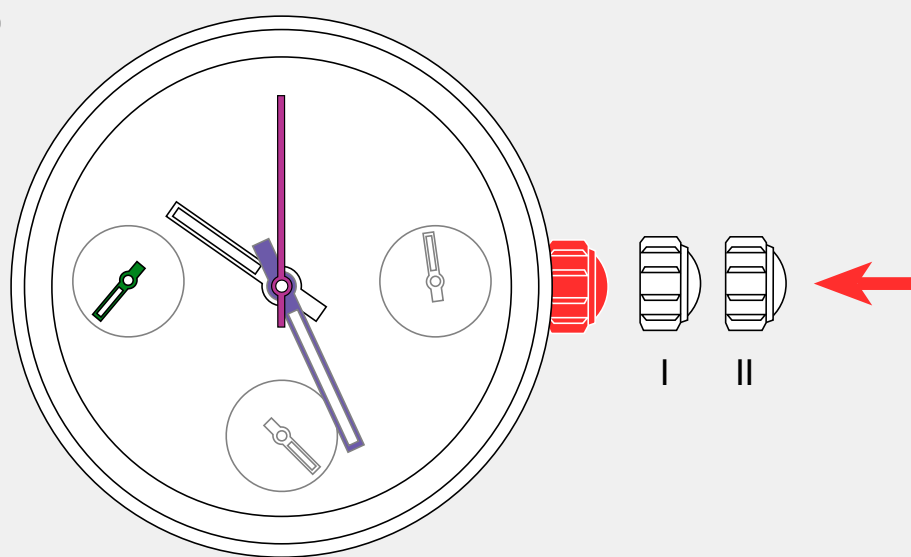

Push the crown back to the normal position in accordance with a time signal.

③

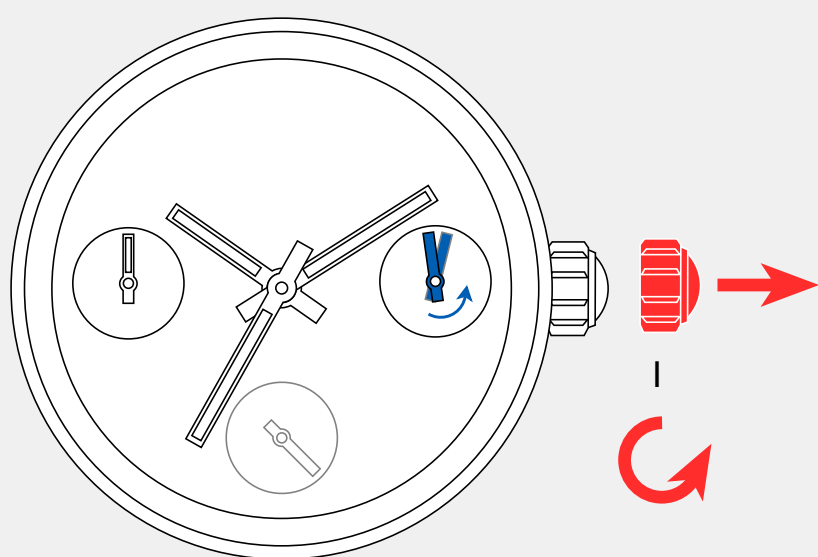

Pull out the crown to the first click. Turn the crown counter-clockwise to set the date.

④

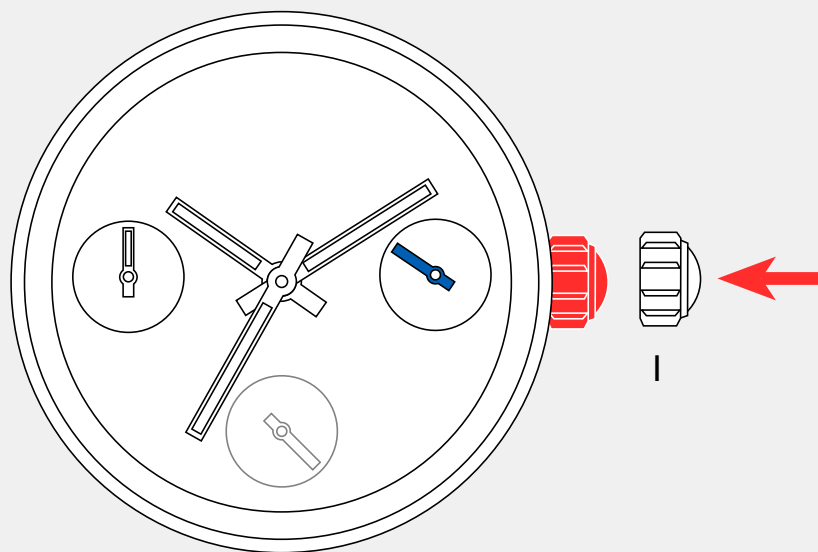

Push the crown back to the normal position.

- Do not set the date between 10:00PM and 2:00AM, otherwise the day may not change properly. If it is necessary to set the date during that time period, firstly change the time to any time outside it and set the date, and then reset the correct time.

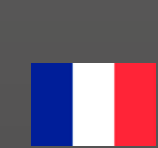

AFFICHAGE ET FONCTIONNEMENT DE LA COURONNE

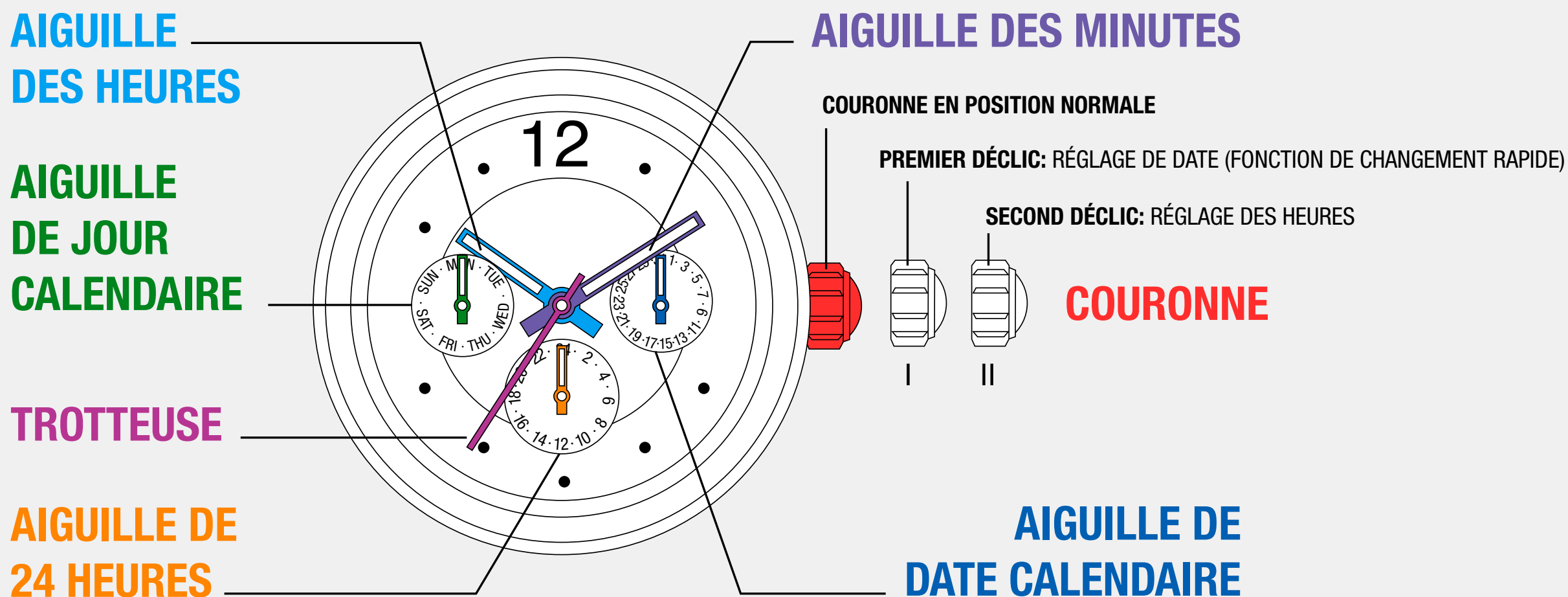

REGLAGE DES HEURES

1

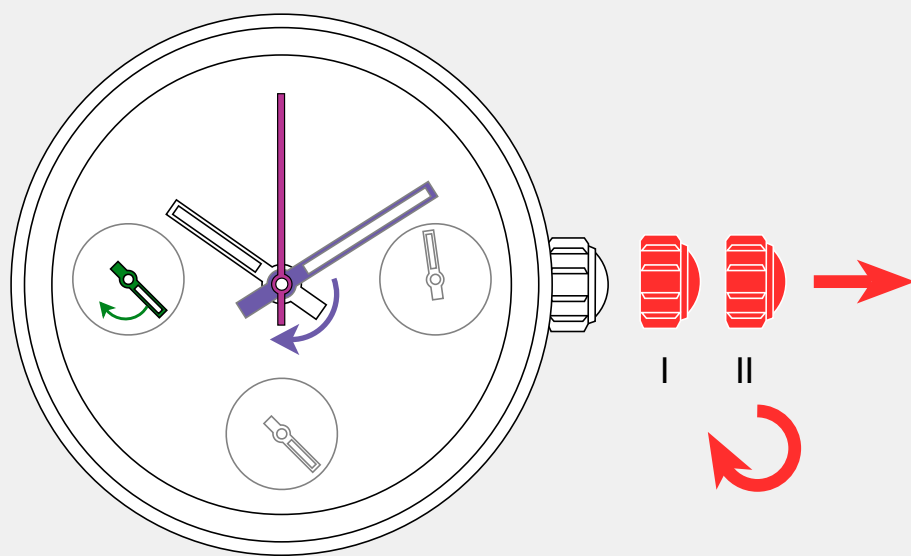

Retirez la couronne au second dé clic quand la trotteuse arrive à la position 12 heures

Tournez la couronne pour régler le jour de la semaine

Tournez la couronne pour régler l'aiguille des heures et l'aiguille des minutes à l'heure souhaitée (vérifiez que le réglage AM/PM (matin/soir) est correct)

2

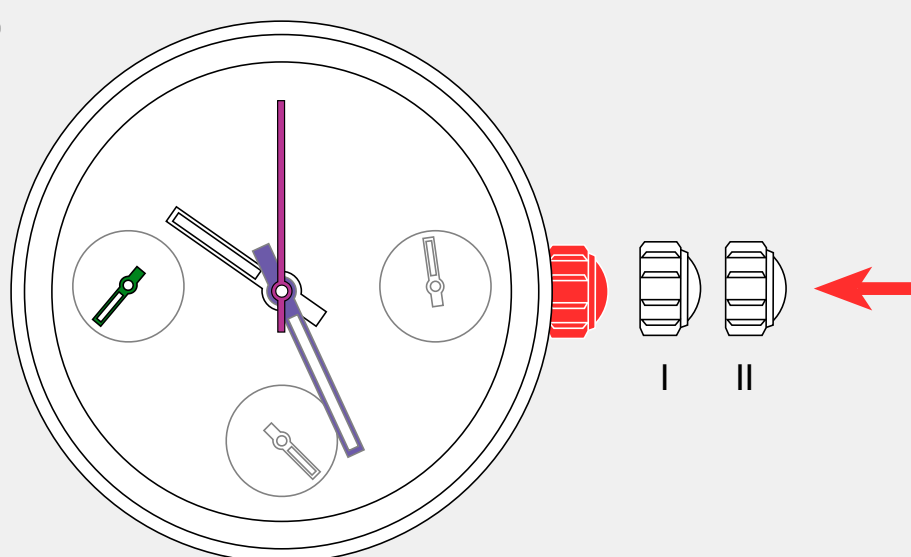

Remettez la couronne en position normale en accord avec un top horaire officiel.

3

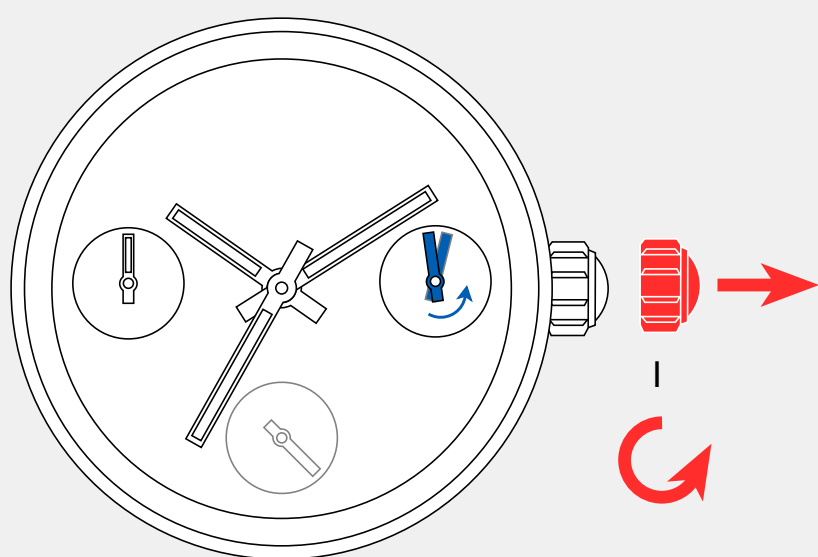

Retirez la couronne au premier dé clic. Tournez-la couronne pour ajuster la montre à l'heure souhaitée.

4

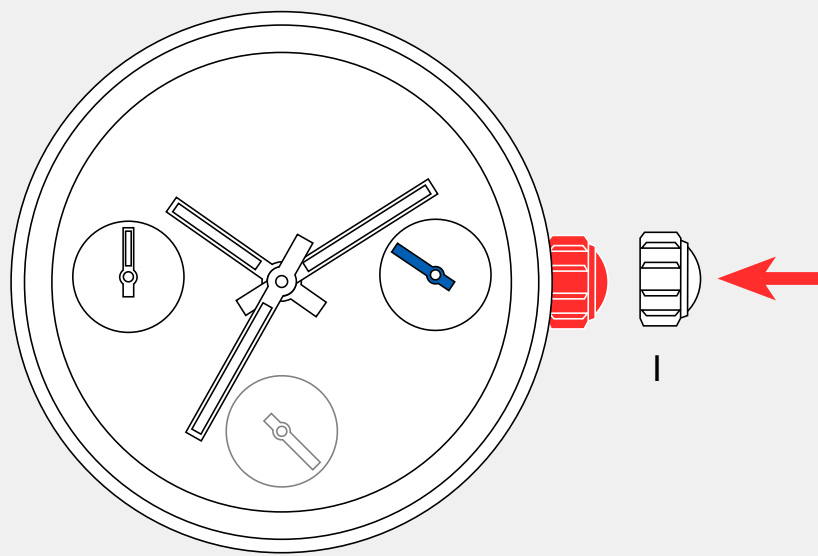

Repoussez la couronne en position normale.

- Ne réglez pas la date entre 22h00 et 2h00, autrement le jour ne changera pas convenablement. S'il est nécessaire de régler la date pendant cette période, passer d'abord à une autre période de la journée, puis ajustez la date. Ensuite, réglez l'heure correctement.



ANZEIGE- UND KRONENBEDIENUNG

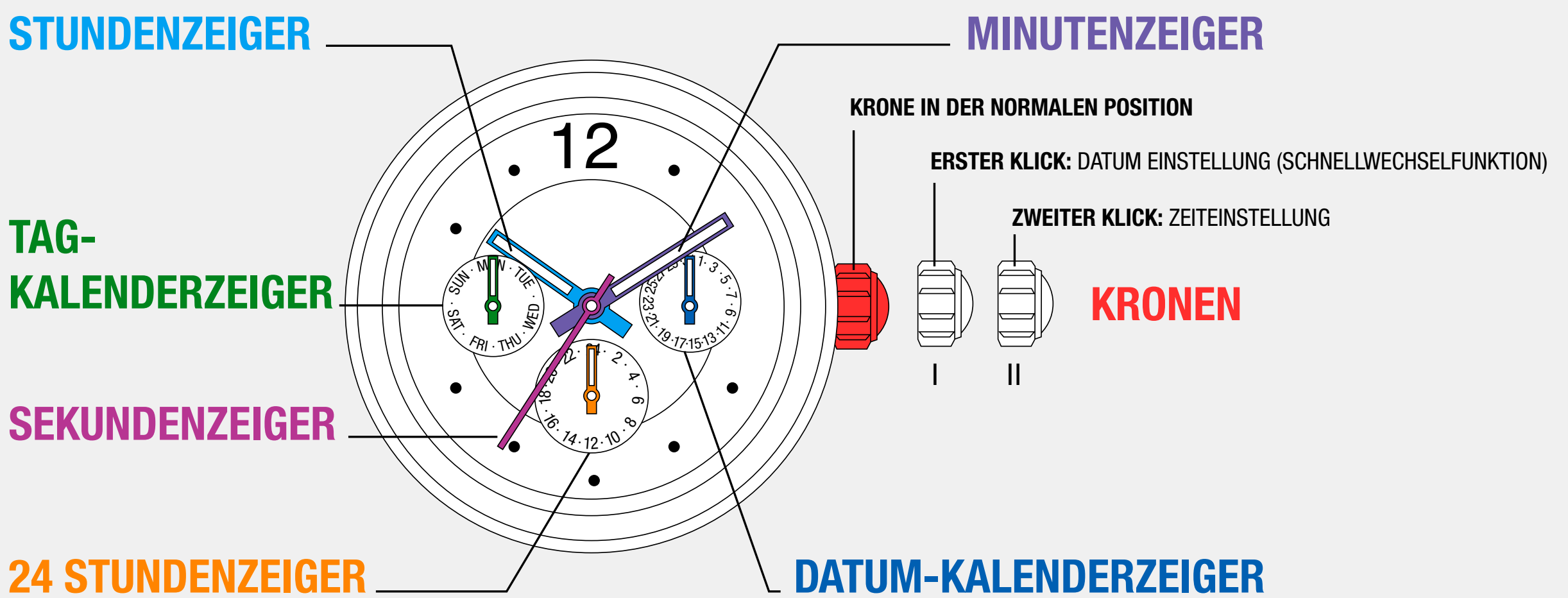

ZEITEINSTELLUNG

1

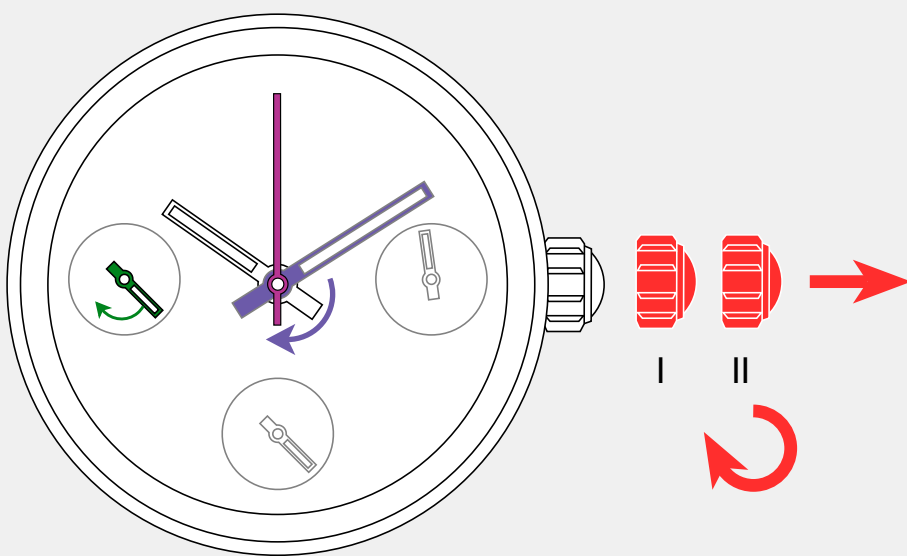

Ziehen Sie Krone bis zum zweiten Klick heraus, wenn die zweite Hand an der 12-Uhr-Position liegt.

Drehen Sie die Krone um den Wochentag einzustellen.

Drehen Sie die Krone, um den Stundenzeiger und den Minutenzeiger auf die korrekte Zeit umzustellen (prüfen Sie nach, dass AM/PM korrekt eingestellt worden ist)

2

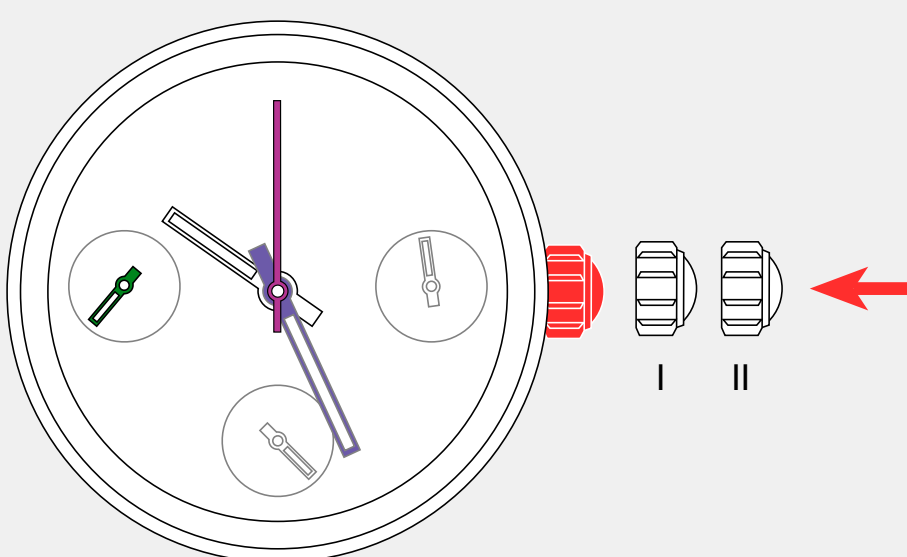

Schieben Sie die Krone bis zur normalen Position entsprechend einem Zeitsignal zurück.

3

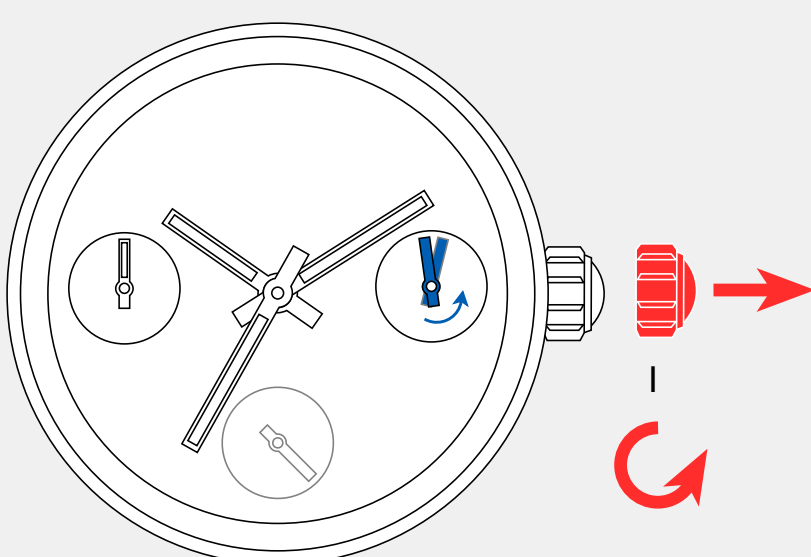

Ziehen Sie die Krone bis zum ersten Klick heraus. Drehen Sie die Krone gegen den Uhrzeigersinn, um das Datum einzustellen.

4

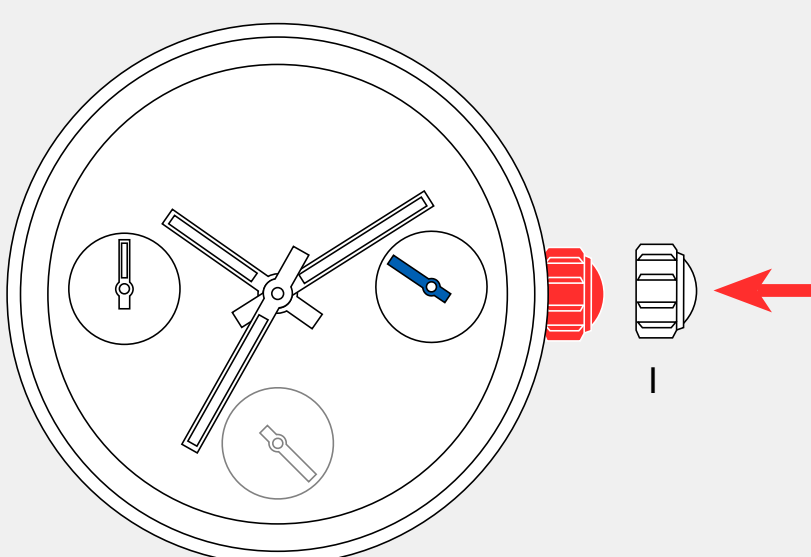

Schieben Sie die Krone zum normalen Position zurück.

- Bitte stellen Sie das Datum nicht zwischen 10:00 Uhr and 2:00 Uhr ein, sonst ist es möglich, dass der Tag nicht korrekt umgestellt wird. Falls Sie das Datum in dieser Zeitperiode einstellen müssen, dann bitte stellen Sie die Zeit erst auf eine Zeit ausserhalb dieses Zeitrahmens um und stellen Sie danach das Datum ein. Anschließend stellen Sie bitte die Zeit korrekt um.

OPERAÇÃO DO MOSTRADOR E DA COROA

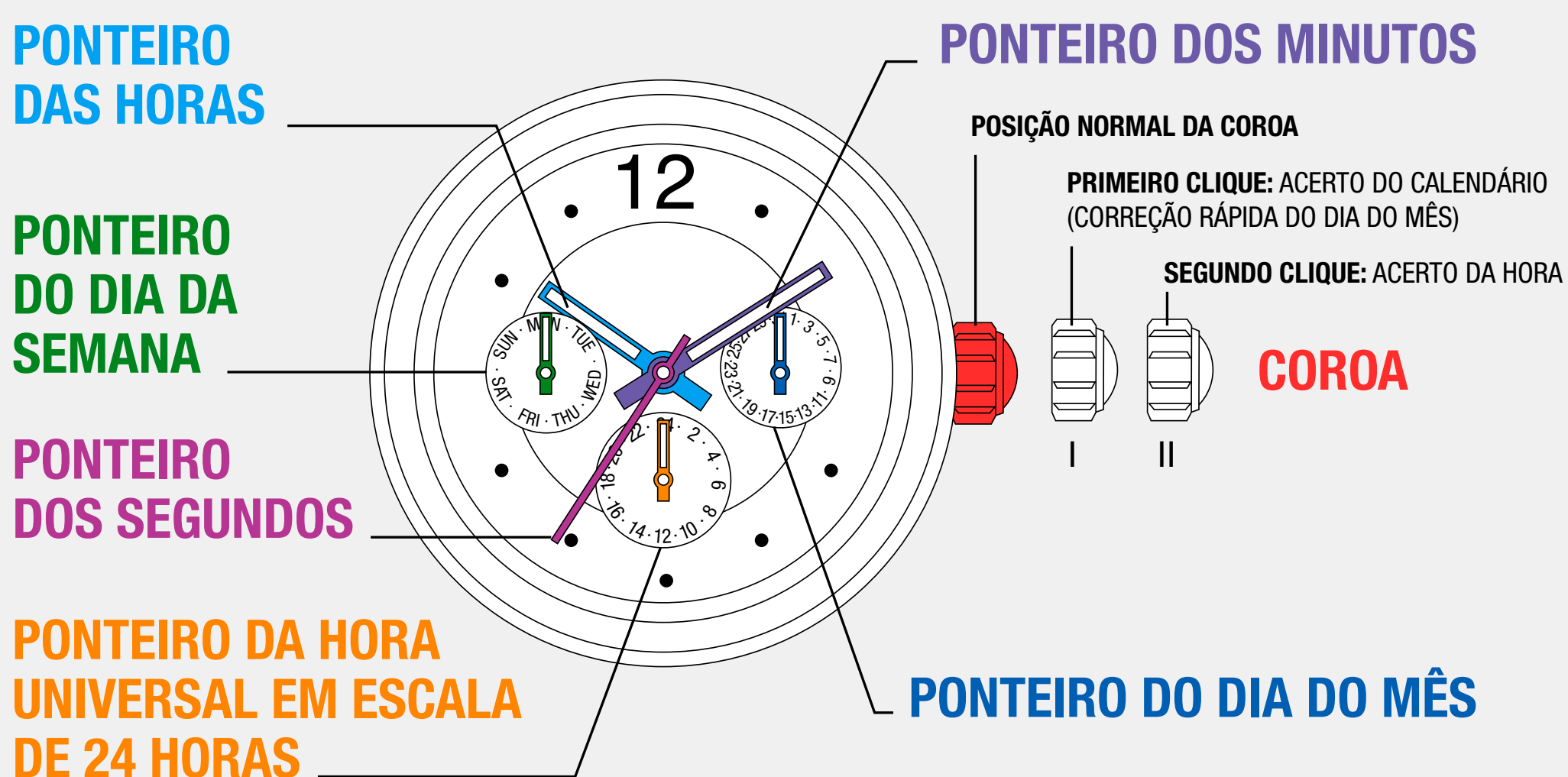

ACERTO DA HORA

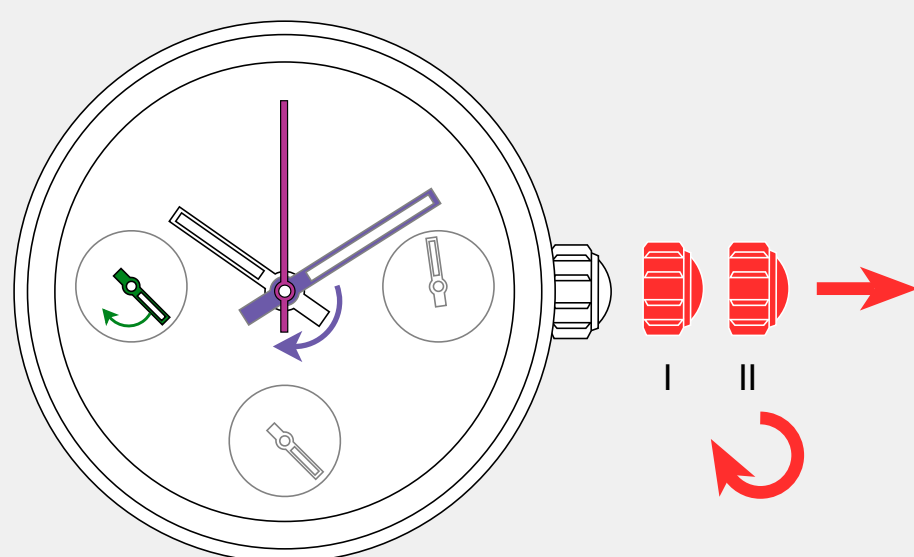
1

Puxe a coroa até o segundo clique quando o ponteiro dos segundos estiver na posição das 12 horas.

Gire a coroa para acertar o dia da semana.

Gire a coroa para acertar o ponteiro das horas e o ponteiro dos minutos na hora actual (certifique-se de que o período AM/PM está fixado correctamente).

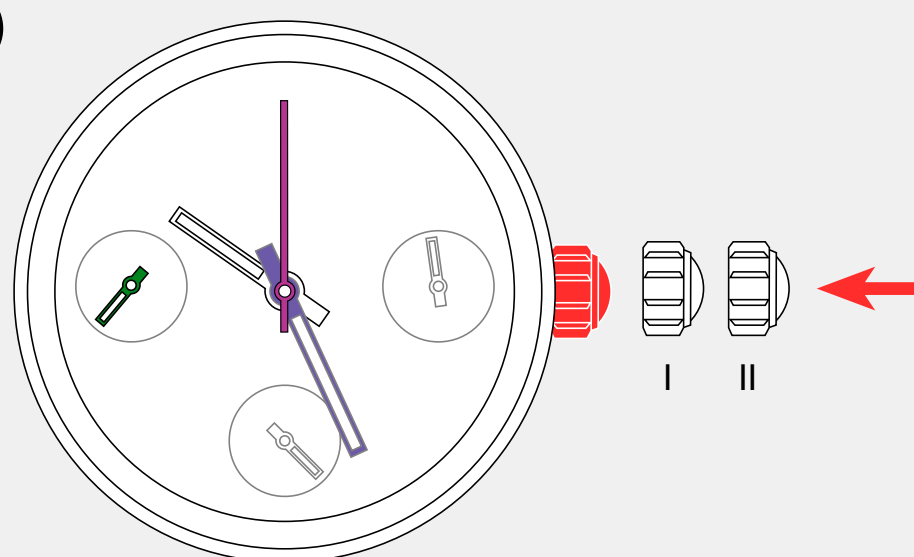
2

Empurre a coroa de volta para a posição normal simultaneamente com o sinal horário.

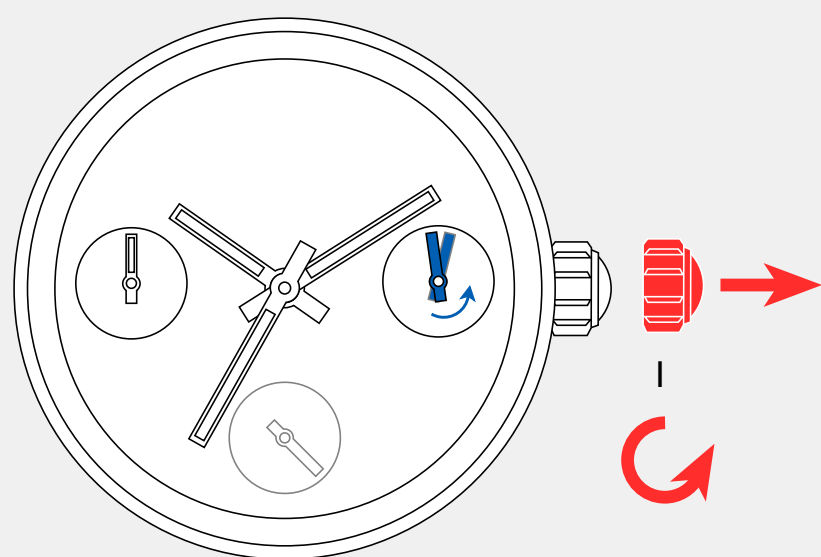
3

Puxe a coroa para o primeiro clique. Gire a coroa no sentido anti-horário para ajustar o dia do mês.

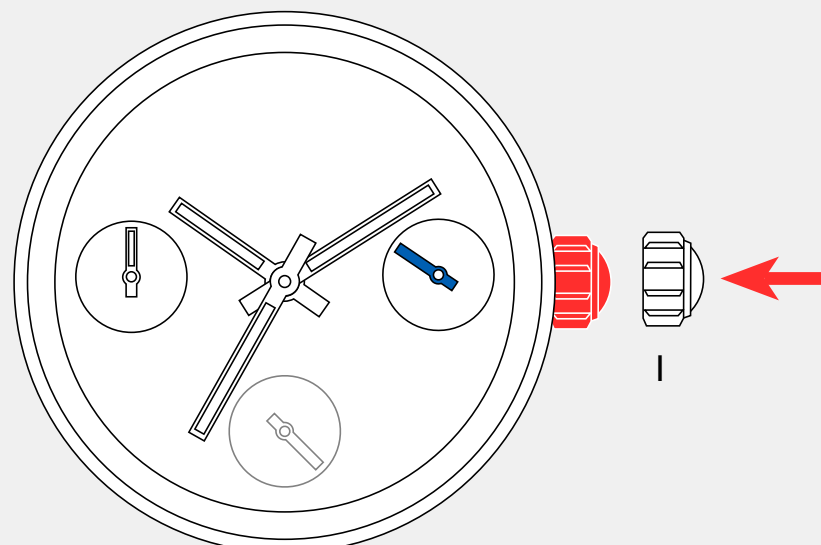
4

Volte a colocar a coroa na posição normal.

- Não acerte o calendário entre as 10:00PM e as 2:00AM. Caso contrário, o dia do mês poderá não mudar adequadamente. Se for necessário acertar o dia do mês durante esse período horário, primeiro mude a hora para qualquer outra fora desse período, e acerte o dia da semana. Logo, em seguida, acerte de novo a hora correcta.